

IEC Appliance Inlet C14 with Filter



Screw-on mounting  
from front side



Snap-in version  
from front side



See below:  
[Approvals and Compliances](#)

**Description**

- Panel mount :  
Snap-in or screw-on mounting front side
- 2 Functions :  
Appliance Inlet Protection class I , Line filter in standard and medical version
- Quick connect terminals 6.3 x 0.8 mm

**Unique Selling Proposition**

- Ultra-compact design
- High quality filter case made of stainless steel
- Highly resistant since potted filter
- Various filter variants

**Characteristics**

- All single elements are already wired
- For applications according IEC/UL 62368-1 we recommend variants with bleed resistor  
Suitable for use in medical equipment according to IEC/UL 60601-1 (1 MOOP, 1 MOPP)

**Other versions on request**

- Capacity CX 100 nF
- Medical Version (M80)

**References**

Alternative: version without line filter [6100-3](#); [6100-4](#)  
 We recommend for new applications the type [5120](#)

**Weblinks**

[pdf data sheet](#), [html datasheet](#), [General Product Information](#), [Approvals](#), [Distributor-Stock-Check](#), [Accessories](#), [Detailed request for product](#)

**Technical Data**

|                                 |  |
|---------------------------------|--|
| Ratings IEC                     | 1 - 10A @ Ta 40 °C / 250 VAC; 50Hz   |
| Ratings UL/CSA                  | 1 - 15A @ Ta 40 °C / 250 VAC; 60Hz   |
| Leakage Current                 | standard < 0.5 mA (250 V / 60 Hz)<br>medical < 5 µA (250 V / 60 Hz)            |
| Dielectric Strength             | > 1.7 kVDC between L-N<br>> 2.7 kVDC between L/N-PE<br>Test voltage (2 sec)    |
| Allowable Operation Temperature | -25 °C to 85 °C  |
| Climatic Category               | 25/085/21 acc. to IEC 60068-1  |
| IP-Protection                   | front side IP40 acc. to IEC 60529  |
| Protection Class                | Suitable for appliances with protection class I acc. to IEC 61140              |
| Terminal                        | Quick connect terminals 6.3 x 0.8 mm   |
| Panel Thickness S               | Screw: max 5 mm<br>Mounting screw torque max 0.5 Nm<br>Snap-in: 0.8 mm to 3 mm |
| Material                        | Thermoplastic, black, UL 94V-0   |

|                         |  |
|-------------------------|--|
| Appliance inlet/-outlet | C14 acc. to IEC 60320-1, UL 498, CSA C22.2 no. 42 (for cold conditions) pin-temperature 70 °C, 10A, Protection Class I |
| Line Filter             | Standard and Medical Version, IEC 60939, UL 1283, CSA C22.2 no. 8<br><a href="#">Technical Details</a>                 |
| MTBF                    | > 3'100'000 h acc. to MIL-HB-217 F   |

**Approvals and Compliances**



Detailed information on product approvals, code requirements, usage instructions and detailed test conditions can be looked up in [Details about Approvals](#)

SCHURTER products are designed for use in industrial environments. They have approvals from independent testing bodies according to national and international standards. Products with specific characteristics and requirements such as required in the automotive sector according to IATF 16949, medical technology according to ISO 13485 or in the aerospace industry can be offered exclusively with customer-specific, individual agreements by SCHURTER.

## Approvals







The approval mark is used by the testing authorities to certify compliance with the safety requirements placed on electronic products.

Approval Reference Type: 5110

| Approval Logo  | Certificates  | Certification Body | Description                            |
|--|---------------|--------------------|--|
|  | VDE Approvals | VDE                | Certificate Number: 40035745           |
|  | UL Approvals  | UL                 | UR File Number: E72928                 |
|  | CQC Approvals | CQC                | CQC Certificate Number: CQC18001207813 |



## Product standards

Product standards that are referenced

| Organization   | Design                | Standard         | Description   |
|--|-----------------------|------------------|---|
|  | Designed according to | IEC 60320-1      | Appliance couplers for household and similar general purposes         |
|  | Designed according to | IEC 60939        | Passive filters for suppressing electromagnetic interference          |
|  | Designed according to | IEC 61058-1      | Switches for appliances. Part 1. General requirements                 |
|  | Designed according to | UL 498           | Standard for Attachment Plugs and Receptacles                         |
|  | Designed according to | UL 1283          | Passive filters for suppressing electromagnetic interference          |
|  | Designed according to | CSA C22.2 no. 42 | General Use Receptacles, Attachment Plugs, and Similar Wiring Devices |
|  | Designed according to | CSA C22.2 no. 8  | Electromagnetic interference (EMI) filters                            |







## Application standards

Application standards where the product can be used

| Organization   | Design                         | Standard       | Description  |
|--|--------------------------------|----------------|--|
|  | Suitable for applications acc. | IEC/UL 62368-1 | Audio/video, information and communication technology equipment - Part 1: Safety requirements          |
|  | Suitable for applications acc. | IEC 60601-1    | Medical electrical equipment - Part 1: General requirements for basic safety and essential performance |

## Compliances

The product complies with following Guide Lines

| Identification   | Details                        | Initiator   | Description   |
|--|--------------------------------|-------------|---|
|  | CE declaration of conformity   | SCHURTER AG | The CE marking declares that the product complies with the applicable requirements laid down in the harmonisation of Community legislation on its affixing in accordance with EU Regulation 765/2008. |
|  | UKCA declaration of conformity | SCHURTER AG | The UKCA marking declares that the product complies with the applicable requirements laid down in the British Amendment of Regulation (EC) 765/2008.  |
|  | RoHS                           | SCHURTER AG | Directive RoHS 2011/65/EU, Amendment (EU) 2015/863  |
|  | China RoHS                     | SCHURTER AG | The law SJ / T 11363-2006 (China RoHS) has been in force since 1 March 2007. It is similar to the EU directive RoHS.  |
|  | REACH                          | SCHURTER AG | On 1 June 2007, Regulation (EC) No 1907/2006 on the Registration, Evaluation, Authorization and Restriction of Chemicals 1 (abbreviated as "REACH") entered into force.                               |
|  | Medical Equipment              | SCHURTER AG | Suitable for use in medical equipment according to IEC/UL 60601-1 (1 MOOP, 1 MOPP)  |

**Dimension [mm]**

Screw-on mounting

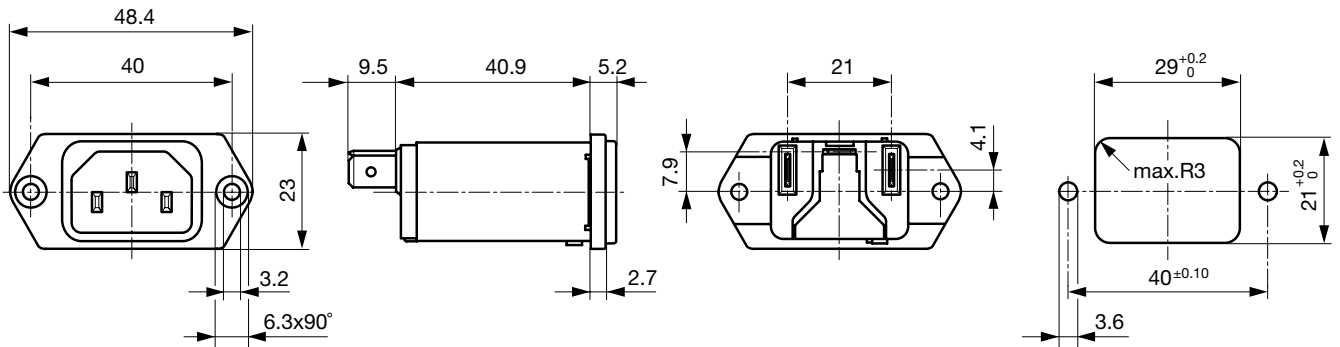

Snap-in mounting

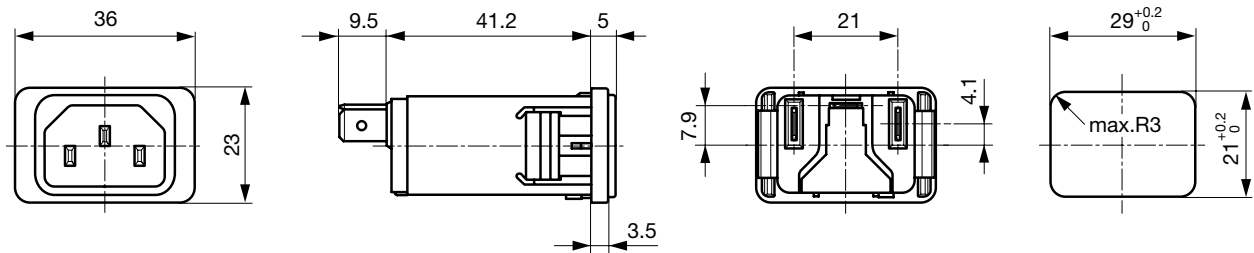

**Technical Data of Filter-Components**

| Rated Current [A] | Filter-Type                  | Inductances L [mH] | Capacitance CX [nF] | Capacitance CY [nF] | R [mΩ] |
|-------------------|------------------------------|--------------------|---------------------|---------------------|--------|
| 1                 | Standard version             | 2 x 11             | 47                  | 2.2                 | -      |
| 2                 | Standard version             | 2 x 4              | 47                  | 2.2                 | -      |
| 3                 | Standard version             | 2 x 2.5            | 47                  | 2.2                 | -      |
| 4                 | Standard version             | 2 x 1.6            | 47                  | 2.2                 | -      |
| 6                 | Standard version             | 2 x 0.7            | 47                  | 2.2                 | -      |
| 8                 | Standard version             | 2 x 0.6            | 47                  | 2.2                 | -      |
| 10                | Standard version             | 2 x 0.4            | 47                  | 2.2                 | -      |
| 15                | Standard version             | 2 x 0.1            | 47                  | 2.2                 | -      |
| 1                 | Medical Version (M5)         | 2 x 11             | 47                  | -                   | 1      |
| 2                 | Medical Version (M5)         | 2 x 4              | 47                  | -                   | 1      |
| 3                 | Medical Version (M5)         | 2 x 2.5            | 47                  | -                   | 1      |
| 4                 | Medical Version (M5)         | 2 x 1.6            | 47                  | -                   | 1      |
| 6                 | Medical Version (M5)         | 2 x 0.7            | 47                  | -                   | 1      |
| 8                 | Medical Version (M5)         | 2 x 0.6            | 47                  | -                   | 1      |
| 10                | Medical Version (M5)         | 2 x 0.4            | 47                  | -                   | 1      |
| 15                | Medical Version (M5)         | 2 x 0.1            | 47                  | -                   | 1      |
| 10                | Standard and Medical Version | 2 x 0.4            | 47                  | 2.2                 | 1      |

Diagrams

Standard version

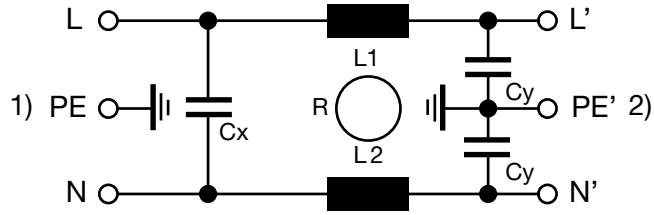

1) Line  
2) Load

Medical Version (M5)

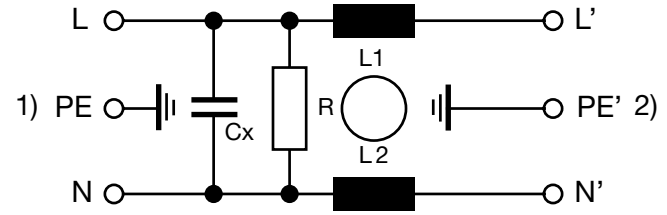

1) Line  
2) Load

Attenuation Loss

--- 50Ω differential mode    \_\_\_ 50Ω common mode

Standard version

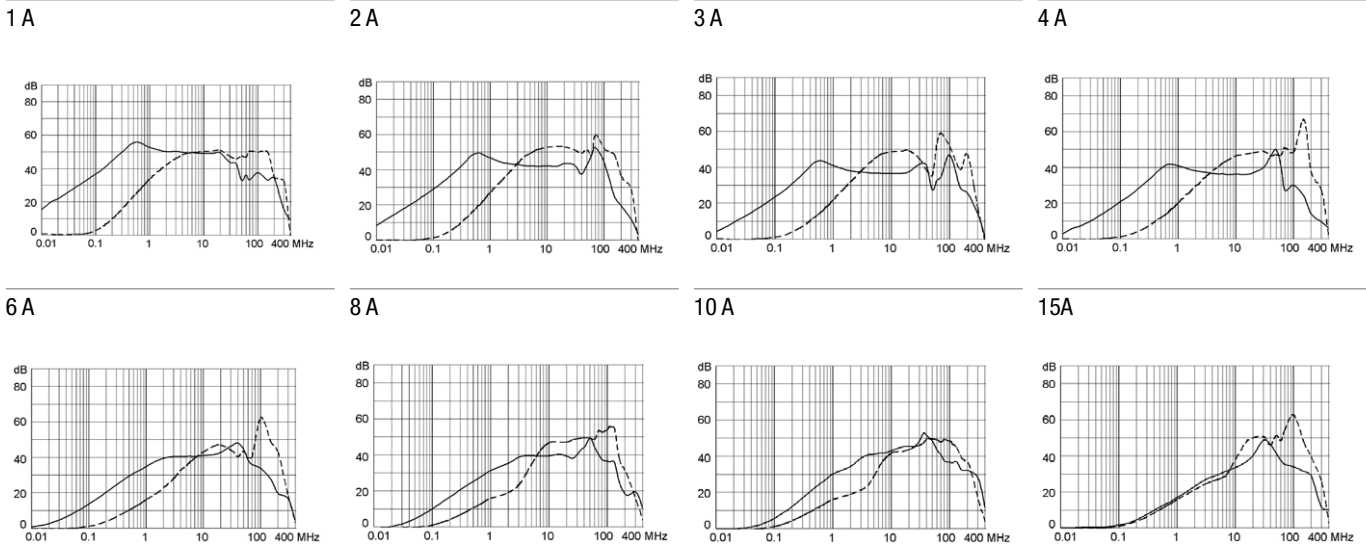

Medical version (M5)

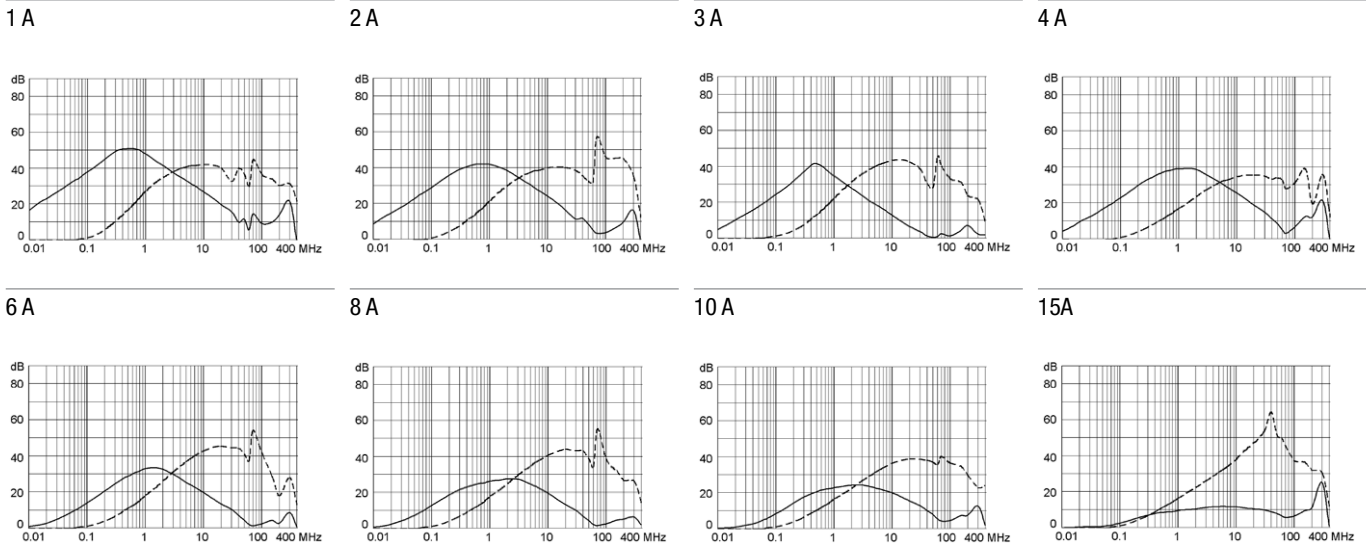

All Variants

| Rated Current [A] | Filter-Type          | Panel mounting | Order Number |
|-------------------|----------------------|----------------|--------------|
| 1                 | Standard version     | Snap-in        | 5110.0143.1  |
| 2                 | Standard version     | Snap-in        | 5110.0243.1  |
| 3                 | Standard version     | Snap-in        | 5110.0343.1  |
| 4                 | Standard version     | Snap-in        | 5110.0443.1  |
| 6                 | Standard version     | Snap-in        | 5110.0643.1  |
| 8                 | Standard version     | Snap-in        | 5110.0843.1  |
| 10                | Standard version     | Snap-in        | 5110.1043.1  |
| 15                | Standard version     | Snap-in        | 5110.1543.1  |
| 1                 | Standard version     | Screw          | 5110.0133.1  |
| 2                 | Standard version     | Screw          | 5110.0233.1  |
| 3                 | Standard version     | Screw          | 5110.0333.1  |
| 4                 | Standard version     | Screw          | 5110.0433.1  |
| 6                 | Standard version     | Screw          | 5110.0633.1  |
| 8                 | Standard version     | Screw          | 5110.0833.1  |
| 10                | Standard version     | Screw          | 5110.1033.1  |
| 15                | Standard version     | Screw          | 5110.1533.1  |
| 1                 | Medical Version (M5) | Snap-in        | 5110.0143.3  |
| 2                 | Medical Version (M5) | Snap-in        | 5110.0243.3  |
| 3                 | Medical Version (M5) | Snap-in        | 5110.0343.3  |
| 4                 | Medical Version (M5) | Snap-in        | 5110.0443.3  |
| 6                 | Medical Version (M5) | Snap-in        | 5110.0643.3  |
| 8                 | Medical Version (M5) | Snap-in        | 5110.0843.3  |
| 10                | Medical Version (M5) | Snap-in        | 5110.1043.3  |
| 15                | Medical Version (M5) | Snap-in        | 5110.1543.3  |
| 1                 | Medical Version (M5) | Screw          | 5110.0133.3  |
| 2                 | Medical Version (M5) | Screw          | 5110.0233.3  |
| 3                 | Medical Version (M5) | Screw          | 5110.0333.3  |
| 4                 | Medical Version (M5) | Screw          | 5110.0433.3  |
| 6                 | Medical Version (M5) | Screw          | 5110.0633.3  |
| 8                 | Medical Version (M5) | Screw          | 5110.0833.3  |
| 10                | Medical Version (M5) | Screw          | 5110.1033.3  |
| 15                | Medical Version (M5) | Screw          | 5110.1533.3  |

Most Popular.

Availability for all products can be searched real-time: <https://www.schurter.com/en/info-center/support-tools/stock-check-distributors>

Packaging unit

10 Pcs

Accessories

Description



[Wire\\_Harness](#)  
 Wire harness for SCHURTER products

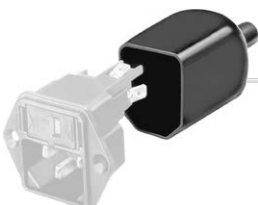

[Assorted\\_Covers](#)  
 Rear Cover

0859.0048



[RC320](#)  
 Rear Cover for Power Entry Module



[Cord\\_retaining\\_kits](#)  
 Cord retaining strain relief

|                |           |
|----------------|-----------|
| Flat head, A   | 4700.0001 |
| Countersunk, C | 4700.0003 |

Mating Outlets/Connectors

Category / Description

[Appliance Outlet Overview complete](#)



|  |      |
|--|------|
| 4787, Mounting: Screw-on mounting, Appliance Outlet: IEC Solder terminals, 10 A, Suitable for appliances with protection class I     | 4787 |
| 4788, Mounting: Snap-in version, Appliance Outlet: IEC Solder / Quick Connect, 10 A, Suitable for appliances with protection class I | 4788 |
| IEC Appliance Outlet F or H, Screw-on Mounting, Front Side, Solder, PCB or Quick-connect Terminal                                    | 5091 |

[Connector Overview complete](#)



|   |         |
|---|---------|
| 4782 Mounting: Power Cord, 3 x 1 mm <sup>2</sup> / 3 x 18 AWG, Cable, Connector: IEC C13    | 4782    |
| 4785 Mounting: Power Cord, 3 x 1 mm <sup>2</sup> / 3 x 18 AWG, Cable, Connector: IEC C13    | 4785    |
| 4300-06 Mounting: Power Cord, 3 x 1 mm <sup>2</sup> / 3 x 18 AWG, Cable, Connector: IEC C13 | 4300-06 |
| 4781 Mounting: Power Cord, Cable, Connector: IEC C15  | 4781    |
| 4784 Mounting: Power Cord, 3 x 1 mm <sup>2</sup> / 3 x 18 AWG, Cable, Connector: IEC C15    | 4784    |