

IEC Connector C13, Rewireable, Angled

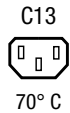

IEC Appliance Outlet C13 for cable mounting
 Screw-on mounting
 angled

4785 Example with assembled cable



See below:
[Approvals and Compliances](#)

Description

- Cord Connectors (Rewireable) :
 Screw-on mounting
- 1 Function
- Connector , Pin temperature 70 °C , Protection class I
- Cable

References

Substitute for type [4013](#); [4021](#)

Weblinks

[pdf data sheet](#), [html datasheet](#), [General Product Information](#), [Distributor-Stock-Check](#), [Accessories](#), [Detailed request for product](#)

Technical Data

Ratings IEC	10A / 250VAC; 50Hz	appliance inlet/-outlet	C13 acc. to IEC 60320-1
Ratings UL/CSA	15A / 250VAC; 60Hz		UL 498, CSA C22.2 no. 42 (for cold conditions) pin-temperature 70 °C, 10A, Protection Class I
Dielectric Strength	> 2 kVAC between L-N > 2 kVAC between L/N-PE (1 min/50Hz)		
Allowable Operation Temperature	-25 °C to 70 °C		
Protection against electric shock	Suitable for appliances with protection class I acc. to IEC 61140		
Terminal	Cable		
Material: Housing	Thermoplastic, black, UL 94V-0		

Approvals and Compliances

Detailed information on product approvals, code requirements, usage instructions and detailed test conditions can be looked up in [Details about Approvals](#)

SCHURTER products are designed for use in industrial environments. They have approvals from independent testing bodies according to national and international standards. Products with specific characteristics and requirements such as required in the automotive sector according to IATF 16949, medical technology according to ISO 13485 or in the aerospace industry can be offered exclusively with customer-specific, individual agreements by SCHURTER.

Approvals





The approval mark is used by the testing authorities to certify compliance with the safety requirements placed on electronic products.

Approval Reference Type: 4785

Approval Logo	Certificates	Certification Body	Description
	VDE Approvals	VDE	VDE Certificate Number: 40031778
	UL Approvals	UL	UL File Number: E96454
	CCC Approvals	CCC	CCC Certificate Number: 2013010204660946

Product standards

Product standards that are referenced

Organization	Design	Standard	Description
	Designed according to	IEC 60320-1	Appliance couplers for household and similar general purposes
	Designed according to	IEC 60320-1	Appliance couplers for household and similar general purposes
	Designed according to	UL 498	Standard for Attachment Plugs and Receptacles
	Designed according to	CSA C22.2 no. 42	General Use Receptacles, Attachment Plugs, and Similar Wiring Devices





Application standards

Application standards where the product can be used

Organization	Design	Standard	Description
	Designed for applications acc.	IEC/UL 60950	IEC 60950-1 includes the basic requirements for the safety of information technology equipment.

Compliances

The product complies with following Guide Lines



Identification	Details	Initiator	Description
	CE declaration of conformity	SCHURTER AG	The CE marking declares that the product complies with the applicable requirements laid down in the harmonisation of Community legislation on its affixing in accordance with EU Regulation 765/2008.
	RoHS	SCHURTER AG	Directive RoHS 2011/65/EU, Amendment (EU) 2015/863
	China RoHS	SCHURTER AG	The law SJ / T 11363-2006 (China RoHS) has been in force since 1 March 2007. It is similar to the EU directive RoHS.
	REACH	SCHURTER AG	On 1 June 2007, Regulation (EC) No 1907/2006 on the Registration, Evaluation, Authorization and Restriction of Chemicals 1 (abbreviated as "REACH") entered into force.

Dimensions [mm]

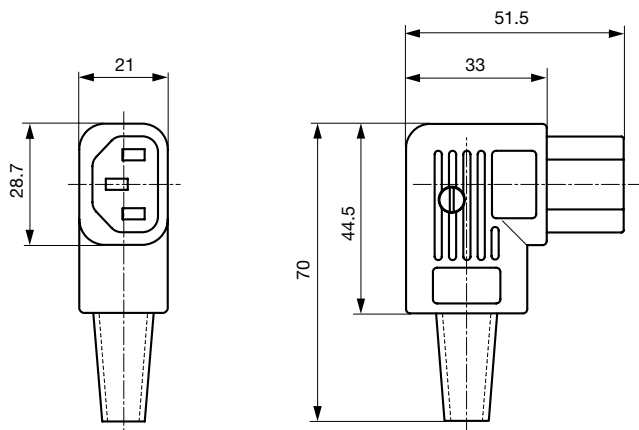
4785



All Variants

Color	Recommended cable diameter	Max. wire size	L = Length of cable guard	Order Number
black	8.5 mm	3 x 1 mm ² / 3 x 18 AWG	-	4785.0000 
black	10 mm	3 x 1.5 mm ² / 3 x 14 AWG	-	4785.0100 

 Most Popular.

Availability for all products can be searched real-time: <https://www.schurter.com/en/Stock-Check/Stock-Check-SCHURTER>

Max. torque for screws: Terminals: 0.5 Nm, Cable clamps: 0.3 Nm, Cover: 0.3 Nm

Packaging unit 100 Pcs

Mating Inlets/Plugs

Category / Description

[Appliance Inlet Overview complete](#)



6100-3, Mounting: Screw, Solder terminals or quick connect terminals, Appliance Inlet: IEC C14	6100-3
6100-4, Mounting: Snap-in, Solder terminals or quick connect terminals, Appliance Inlet: IEC C14	6100-4
6102-3, Mounting: Screw, Solder terminals or quick connect terminals, Appliance Inlet: IEC C18	6102-3
6102-5, Mounting: Snap-in, Solder terminals or quick connect terminals, Appliance Inlet: IEC C18	6102-5
G-Stecker, Mounting: Appliance Inlet : IEC C14 Without fuse holder	6150
Appliance Inlet further types to 4785	...

[Distribution Unit Overview complete](#)



0712-PQ, Mounting: Snap-in, Front Side, Solder terminal (4.8 x 0.8 mm), 1x Appliance Outlet: IEC F	0712
4741, Mounting: 2x Appliance Outlet: IEC F	4741
4747, Mounting: 4x Appliance Outlet: IEC F	4747
4740, Mounting: 6x Appliance Outlet: IEC F	4740
Distribution Unit further types to 4785	...

[IEC Inlet Filter Overview complete](#)



GRF2, Mounting: Rear Side, With EMC-shield and without line filter, 10 A, Plug Connector, Appliance Inlet: IEC C14, Suitable for appliances with protection class I	GRF2
5110, Mounting: Screw, Front Side, Filter: Standard and Medical Version, Without fuse holder: 10 A, Thermoplastic Appliance Inlet: IEC C14, prewired, Suitable for appliances with protection class I	5110
KFS, Mounting: Screw, Front Side, Filter: Standard Version, Without fuse holder: 10 A, Appliance Inlet: IEC C14, pre-wired	KFS
IEC Inlet Filter further types to 4785	...

[Plug Overview complete](#)



4732, Mounting: Power Cord, Plug: IEC E, Cable	4732
4735, Mounting: Power Cord, Plug: IEC E, Cable	4735
9009, Mounting: Plug: IEC E, Screw clamps	9009
4733, Mounting: Power Cord, Plug: IEC E, Cable	4733
4736, Mounting: Power Cord, Plug: IEC E, Cable	4736
Plug further types to 4785	...

[Power Entry Module Overview complete](#)



DD11, Mounting: Screw-on mounting, Rocker switch: non-illuminated or illuminated 2-pole, Quick connect terminals 4.8 x 0.8 mm, Appliance Inlet: IEC C14, With or without protection cover, Fuseholder: 1 or 2 pole, Suitable for appliances with protection class I	DD11
DD21, Mounting: Screw-on mounting Rear Side, Rocker switch: non-illuminated or illuminated 2-pole, additional quick connect 4.8 x 0.8 mm Appliance Inlet: IEC C14, Fuseholder: 1 or 2 pole	DD21
DC11, Mounting: Screw, Rocker switch: non-illuminated or illuminated 1 or 2 pole, Quick connect terminals 4.8 x 0.8 mm, Appliance Inlet: IEC C14, Without fuse holder: Suitable for appliances with protection class I or II	DC11
KEB1, Mounting:Screw, Quick connect terminals 4.8 x 0.8 mm, Without fuse holder: Rocker switch, non-illuminated, 1-pole, Appliance Inlet: IEC C14, 250 VAC, prewired, Suitable for appliances with protection class I	KEB1
KEB2, Mounting:Screw, Quick connect terminals 4.8 x 0.8 mm, Without fuse holder: Rocker switch, non-illuminated or illuminated, 2-pole, Appliance Inlet: IEC C14, 250 VAC, prewired, Suitable for appliances with protection class I	KEB2
Power Entry Module further types to 4785	...

[Power Entry Module with line filter Overview complete](#)



DG12, Mounting : Screw, 8 mm, 15 A, prewired, Standard and Medical Version, Appliance Inlet: IEC C14 C18, Circuit Breakers TA35: DG12, Suitable for appliances with protection class I or II	DG12
DD14, Mounting: Screw-on mounting, Front Side, Filter, Standard and Medical Version, Fuseholder:1 or 2 pole, 10 A, Rocker switch: 2-pole, non-illuminated Appliance Inlet: IEC C14, prewired	DD14
KFB1, Mounting: Screw, Front Side, Filter: Standard Version, Without fuse holder: 10 A, Rocker switch: 1-pole, Appliance Inlet: IEC C14, prewired	KFB1
KFB2, Mounting: Screw, Front Side, Filter: Standard and Medical Version, Without fuse holder: 10 A, Rocker switch: 2-pole, Appliance Inlet: IEC C14, prewired	KFB2
DC12, Mounting: Screw, Front-/Rear-Side, Filter, Standard and Medical Version, Without fuse holder:10 A, Rocker switch: 1 or 2 pole, non-illuminated or illuminated Appliance Inlet: IEC C14, prewired	DC12
Power Entry Module with line filter further types to 4785	...

The specifications, descriptions and illustrations indicated in this document are based on current information. All content is subject to modifications and amendments. Information furnished is believed to be accurate and reliable. However, users should independently evaluate the suitability and test each product selected for their own applications.